

101

C O P E N H A G E N



Product no: 203040

Type: Chandelier / Indoor

Designer / Year of design:

Kristian Sofus Hansen & Tommy Hyldahl, 2017

Colour / Material: Brass

Lampshade & Ceiling cup: 100% Iron, with plated brass finish. Pipes & attachment parts is made of 100% oxidized brass and brushed afterwards: Brass Oxidized

Cable: Fabric covered cable / Black

Dimensions:

L111 / W78,5 / H54 CM

Mounting plate: H1,3 / W5,5 CM

Ceiling cup: H18 / W6 CM

Fabric covered cable (divided in two):

Cable 1. from 15 to 85 CM / Cable 2. 200 CM

Country of origin: CN

Product weight: 4,2 Kgs

Packaging:

Dimensions: L90 / W91 / H22 CM

Total weight incl. product: 6,3 Kgs

Number of parcels: 1

Material: Brown cardboard

Light source:

Socket: E14 - B35 4.3W 827 - 230V

Recommended Light Source:

Pygmy - Matt Porcelain - E14

IP rating: 20 Max Watt: 48

Please note this chandelier is not dimmable.

Dimmability: Can be fitted with an aligned dimmer

Care instructions:

Use a soft dry cloth to clean the product.

Do not use household cleaners.

Be careful when adjusting the lampshades.

Suitable for rooms with a height of 230-320 CM.

Certificates: EMC - LVD

Does not comply with US Standards.

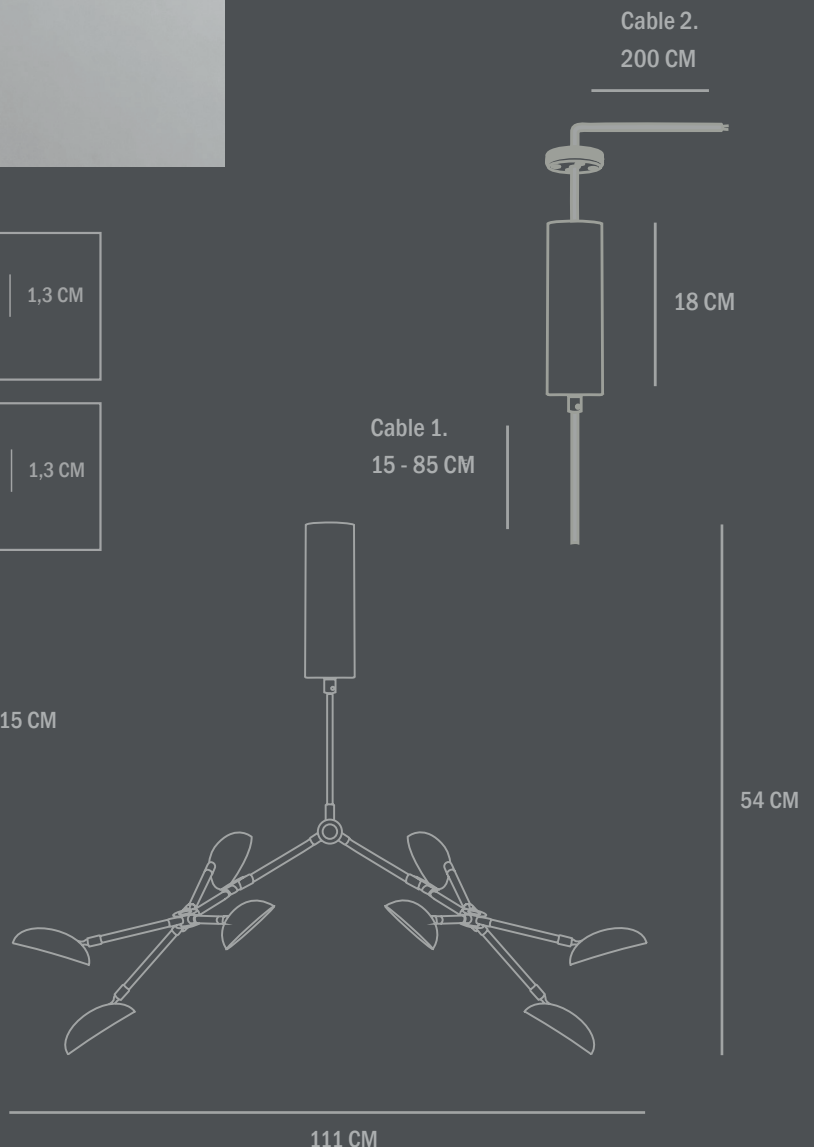
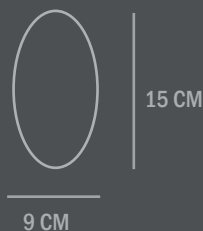
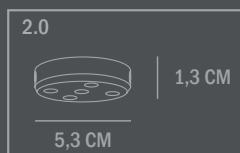
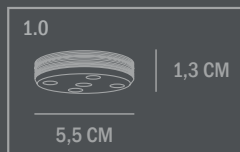

DROP CHANDELIER MINI

You almost feel the movement of the Drop Chandelier. As a free-flowing sculpture, it takes in the space and insists on a life of its own.

While The Drop Chandelier collection honors modernist lamp designs of the 1950s, it also celebrates an experimental, innovative approach with its gently curving shades and 14 flexible and functional adjustable arms - creating countless options, variations, and angles.

The beautifully crafted oxidized and plated, metal body is subsequently hand brushed and the lamp brightens up the room elegantly with a warm, pleasant light.

Designed by Kristian Sofus Hansen & Tommy Hyldahl.

101

C O P E N H A G E N



DROP CHANDELIER MINI

You almost feel the movement of the Drop Chandelier. As a free-flowing sculpture, it takes in the space and insists on a life of its own.

While The Drop Chandelier collection honors modernist lamp designs of the 1950s, it also celebrates an experimental, innovative approach with its gently curving shades and 14 flexible and functional adjustable arms - creating countless options, variations, and angles.

The beautifully crafted oxidized and plated, metal body is subsequently hand brushed and the lamp brightens up the room elegantly with a warm, pleasant light.

Designed by Kristian Sofus Hansen & Tommy Hyldahl.

Product no: 211001

Type: Chandelier / Indoor
Designer / Year of design:
Kristian Sofus Hansen & Tommy Hyldahl, 2017

Colour / Material: Oxidized
Lampshade: Oxidized Aluminium
Pipes: Brass Oxidized / Unpolished
Cable: Fabric covered cable / Black

Dimensions:
L111 / W78,5 / H54 CM
Mounting plate: H1,3 / W5,5 CM
Ceiling cup: H18 / W6 CM
Fabric covered cable (divided in two):
Cable 1. from 15 to 85 CM / Cable 2. 200 CM

Country of origin: CN
Product weight: 4,2 Kgs

Packaging:
Dimensions: L90 / W91 / H22 CM
Total weight incl. product: 6,3 Kgs
Number of parcels: 1
Material: Brown cardboard

Light source:
Socket: E14 - B35 4.3W 827 - 230V
Recommended Light Source:
Pygmy - Matt Porcelain - E14
IP rating: 20 Max Watt: 48

Please note this chandelier is not dimmable.
Dimmability: Can be fitted with an aligned dimmer

Care instructions:
Use a soft dry cloth to clean the product.
Do not use household cleaners.
Be careful when adjusting the lampshades.

Suitable for rooms with a height of 230-320 CM.
Certificates: EMC - LVD
Does not comply with US Standards.

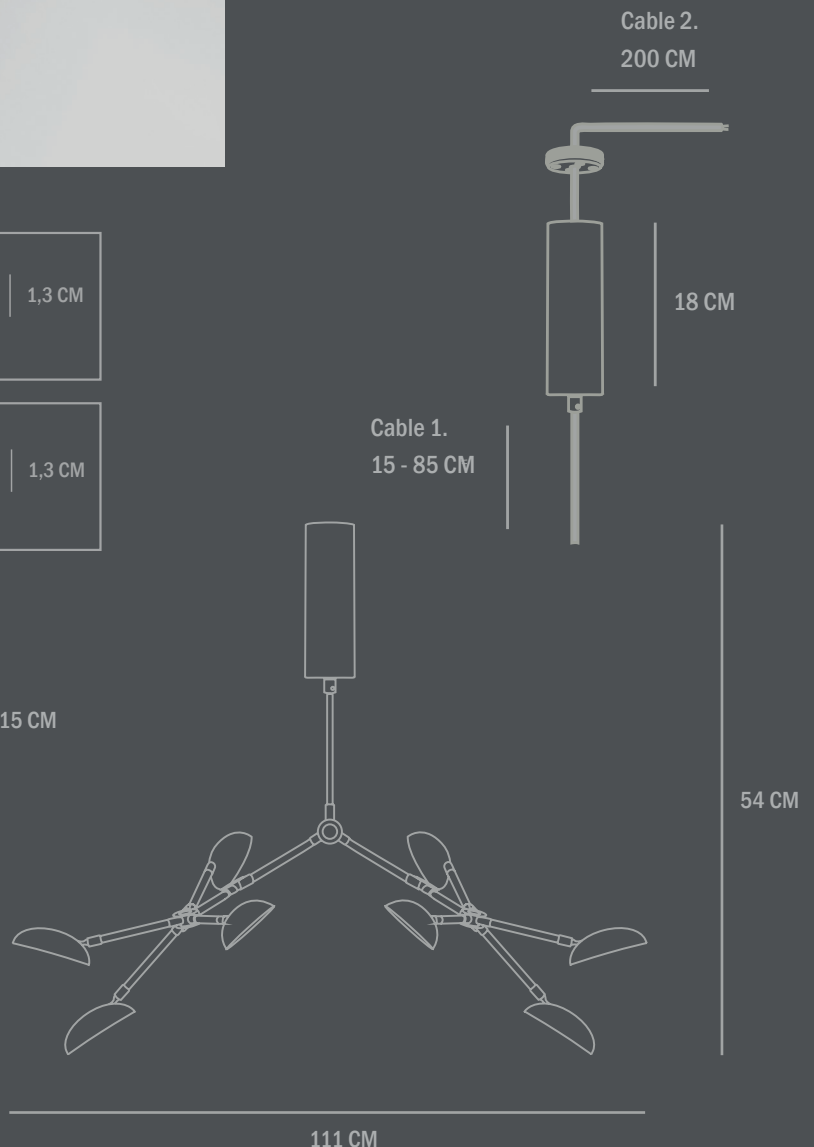
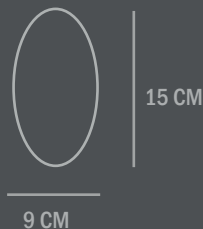
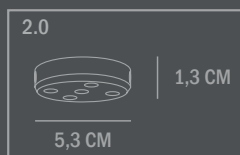
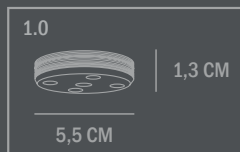

101

C O P E N H A G E N



Product no: 214021

Type: Chandelier / Indoor
Designer / Year of design:
Kristian Sofus Hansen & Tommy Hyldahl, 2017

Colour / Material: Burned Black
Lampshade & Ceiling cup: 100% Iron, with plated Burned Black finish. Pipes & attachment parts is made of 100% Iron color bronze and polished afterwards.
Cable: Fabric covered cable / Black

Dimensions:
L111 / W78,5 / H54 CM
Mounting plate: H1,3 / W5,5 CM
Ceiling cup: H18 / W6 CM
Fabric covered cable (divided in two):
Cable 1. from 15 to 85 CM / Cable 2. 200 CM

Country of origin: CN
Product weight: 4,2 Kgs

Packaging:
Dimensions: L90 / W91 / H22 CM
Total weight incl. product: 6,3 Kgs
Number of parcels: 1
Material: Brown cardboard

Light source:
Socket: E14 - B35 4.3W 827 - 230V
Recommended Light Source:
Pygmy - Matt Porcelain - E14
IP rating: 20 Max Watt: 48

Please note this chandelier is not dimmable.
Dimmability: Can be fitted with an aligned dimmer

Care instructions:
Use a soft dry cloth to clean the product.
Do not use household cleaners.
Be careful when adjusting the lampshades.

Suitable for rooms with a height of 230-320 CM.
Certificates: EMC - LVD
Does not comply with US Standards.

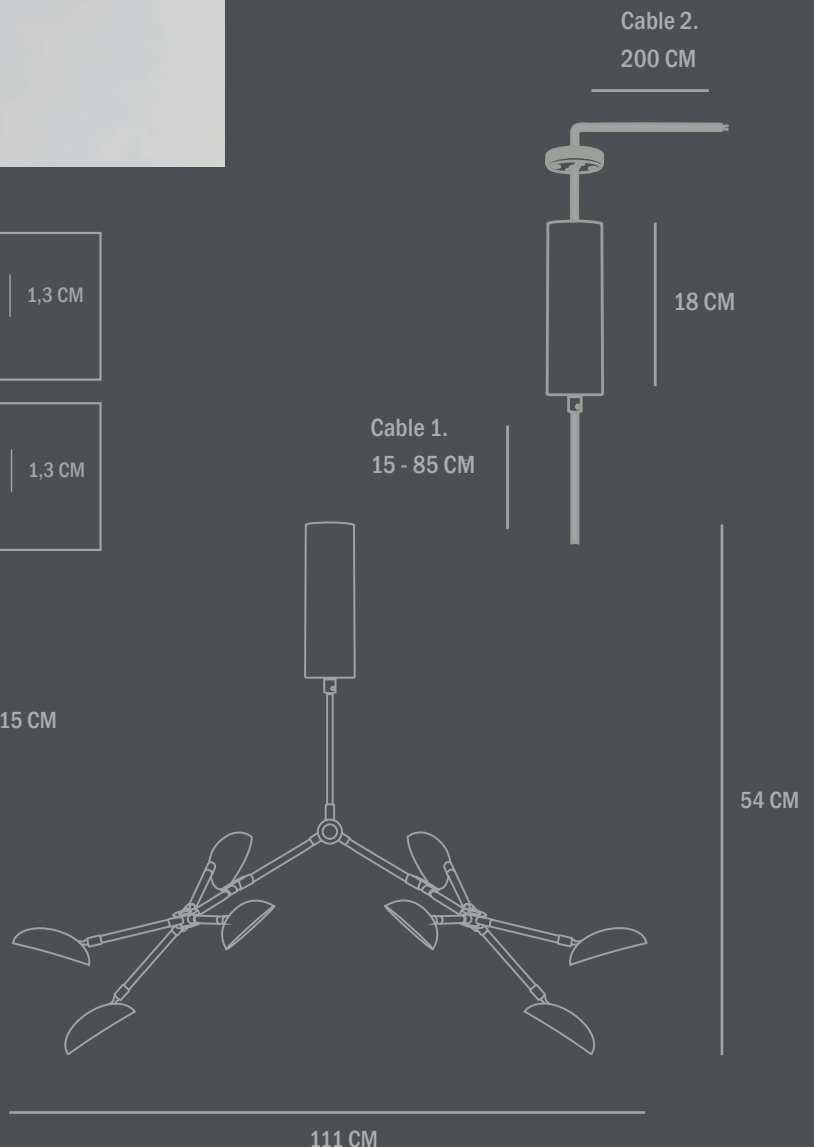
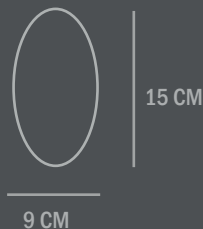
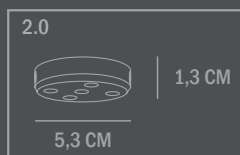
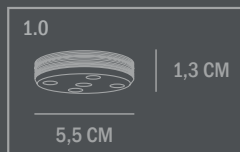

DROP CHANDELIER MINI

You almost feel the movement of the Drop Chandelier. As a free-flowing sculpture, it takes in the space and insists on a life of its own.

While The Drop Chandelier collection honors modernist lamp designs of the 1950s, it also celebrates an experimental, innovative approach with its gently curving shades and 14 flexible and functional adjustable arms - creating countless options, variations, and angles.

The beautifully crafted oxidized and plated, metal body is subsequently hand brushed and the lamp brightens up the room elegantly with a warm, pleasant light.

Designed by Kristian Sofus Hansen & Tommy Hyldahl.

101

C O P E N H A G E N

DROP CHANDELIER MINI

You almost feel the movement of the Drop Chandelier. As a free-flowing sculpture, it takes in the space and insists on a life of its own.

While The Drop Chandelier collection honors modernist lamp designs of the 1950s, it also celebrates an experimental, innovative approach with its gently curving shades and 14 flexible and functional adjustable arms - creating countless options, variations, and angles.

The beautifully crafted oxidized and plated, metal body is subsequently hand brushed and the lamp brightens up the room elegantly with a warm, pleasant light.

Designed by Kristian Sofus Hansen & Tommy Hyldahl.



Product no: 214023

Type: Chandelier / Indoor
Designer / Year of design:
Kristian Sofus Hansen & Tommy Hyldahl, 2017

Colour / Material: Bronze
Lampshade & Ceiling cup: 100% Iron, with plated Bronze finish. Pipes & attachment parts is made of 100% Iron color bronze and polished afterwards.
Cable: Fabric covered cable / Black

Dimensions:
L111 / W78,5 / H54 CM
Mounting plate: H1,3 / W5,5 CM
Ceiling cup: H18 / W6 CM
Fabric covered cable (divided in two):
Cable 1. from 15 to 85 CM / Cable 2. 200 CM

Country of origin: CN
Product weight: 4,2 Kgs

Packaging:
Dimensions: L90 / W91 / H22 CM
Total weight incl. product: 6,3 Kgs
Number of parcels: 1
Material: Brown cardboard

Light source:
Socket: E14 - B35 4.3W 827 - 230V
Recommended Light Source:
Pygmy - Matt Porcelain - E14
IP rating: 20 Max Watt: 48

Please note this chandelier is not dimmable.
Dimmability: Can be fitted with an aligned dimmer

Care instructions:
Use a soft dry cloth to clean the product.
Do not use household cleaners.
Be careful when adjusting the lampshades.

Suitable for rooms with a height of 230-320 CM.
Certificates: EMC - LVD
Does not comply with US Standards.

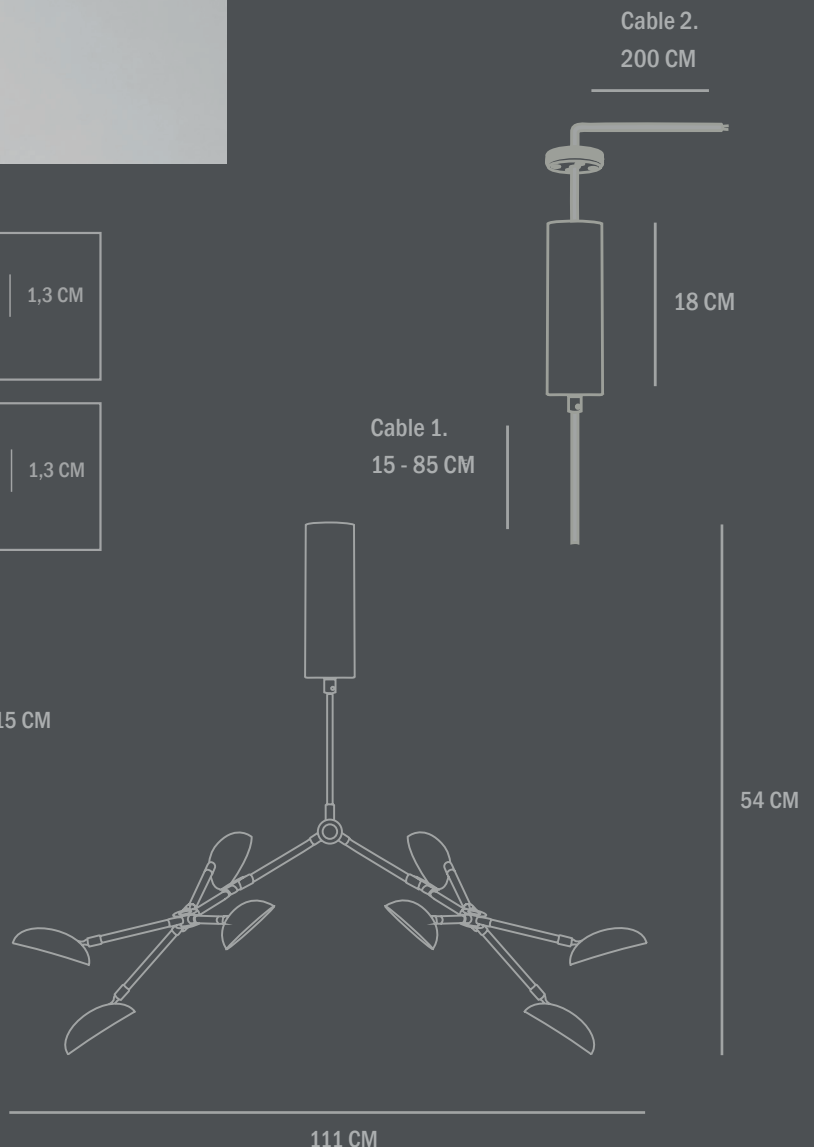
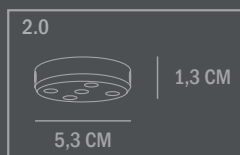
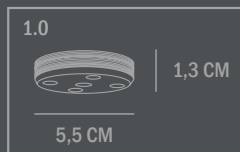

101

C O P E N H A G E N



DROP CHANDELIER BRASS

You almost feel the movement of the Drop Chandelier. As a free-flowing sculpture, it takes in the space and insists on a life of its own.

While The Drop Chandelier collection honors modernist lamp designs of the 1950s, it also celebrates an experimental, innovative approach with its gently curving shades and 14 flexible and functional adjustable arms - creating countless options, variations, and angles.

The beautifully crafted oxidized and plated, metal body is subsequently hand brushed and the lamp brightens up the room elegantly with a warm, pleasant light.

Designed by Kristian Sofus Hansen & Tommy Hyldahl.

Product no: 110049

Type: Chandelier / Indoor

Colour / Material: Brass

Designer / Year of design:

Kristian Sofus Hansen & Tommy Hyldahl, 2016

Lampshade & Ceiling cup: 100% Iron, with plated Brass finish. Pipes & attachment parts is made of 100% Iron color brass and polished afterwards.

Cable: Fabric covered cable / Black

Dimensions:

L154 / W121 / H73 CM

Mounting plate: H1,3/W5,5 CM

Ceiling cup: H18 / W6 CM

Fabric covered cable (divided in two):

Cable 1. from 15 to 85 CM / Cable 2. 200 CM

Country of origin: CN

Product weight: 6 Kgs

Packaging:

Dimensions: L109 / W89 / H21 CM

Total weight incl. product: 8,90 Kgs

Number of parcels: 1

Material: Brown cardboard

Light source:

Socket: E14 - B35 4.3W 827 - 230V

Recommended Light Source:

Pygmy - Matt Porcelain - E14

IP rating: 20 Max Watt: 48

Please note this chandelier is not dimmable.

Dimmability: Can be fitted with an aligned dimmer

Care instructions:

Use a soft dry cloth to clean the product.

Do not use household cleaners.

Be careful when adjusting the lampshades.

Suitable for rooms with a height of 230-320 CM.

Certificates: EMC - LVD

Does not comply with US Standards.

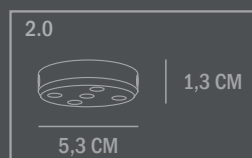
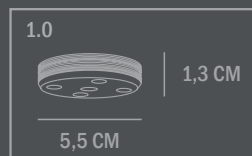

12 CM

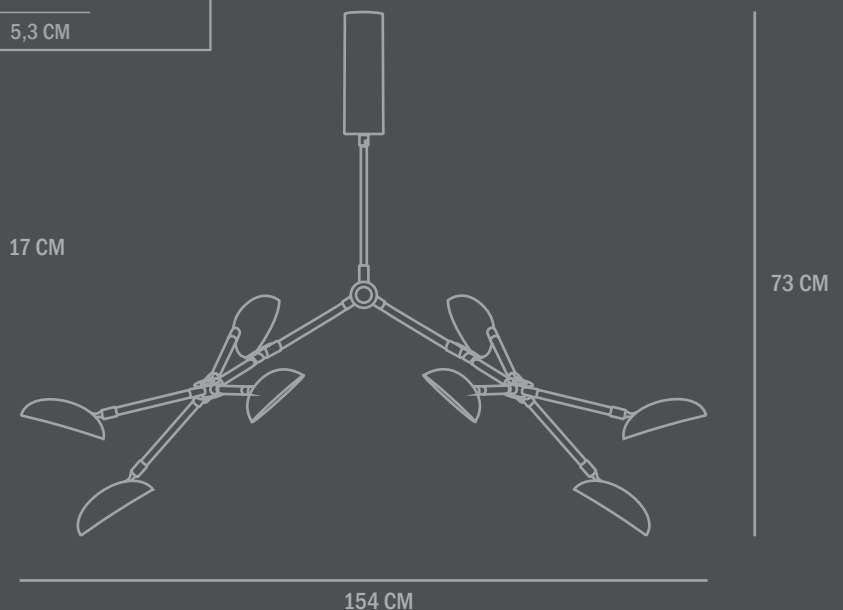

101

C O P E N H A G E N

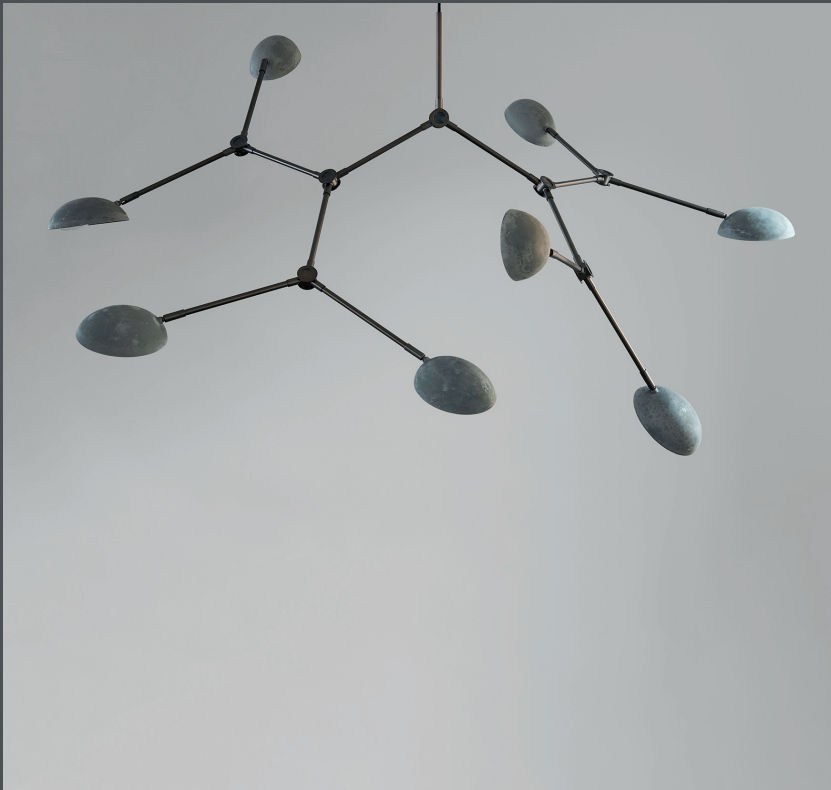

DROP CHANDELIER OXIDIZED

You almost feel the movement of the Drop Chandelier. As a free-flowing sculpture, it takes in the space and insists on a life of its own.

While The Drop Chandelier collection honors modernist lamp designs of the 1950s, it also celebrates an experimental, innovative approach with its gently curving shades and 14 flexible and functional adjustable arms - creating countless options, variations, and angles.

The beautifully crafted oxidized and plated, metal body is subsequently hand brushed and the lamp brightens up the room elegantly with a warm, pleasant light.

Designed by Kristian Sofus Hansen & Tommy Hyldahl.

Product no: 111098

Type: Chandelier / Indoor
Colour / Material: Oxidized
Designer / Year of design:
Kristian Sofus Hansen & Tommy Hyldahl, 2016

Lampshade: Oxidized Aluminium
Pipes: Brass Oxidized / Unpolished
Cable: Fabric covered cable / Black

Dimensions:
L154 / W121 / H73 CM
Mounting plate: H1,3/W5,5 CM
Ceiling cup: H18 / W6 CM
Fabric covered cable (divided in two):
Cable 1. from 15 to 85 CM / Cable 2. 200 CM

Country of origin: CN.
Product weight: 6 Kgs

Packaging:
Dimensions: L109 / W89 / H21 CM
Total weight incl. product: 8,90 Kgs
Number of parcels: 1
Material: Brown cardboard

Light source:
Socket: E14 - B35 4.3W 827 - 230V
Recommended Light Source:
Pygmy - Matt Porcelain - E14
IP rating: 20 Max Watt: 48

Please note this chandelier is not dimmable.
Dimmability: Can be fitted with an aligned dimmer

Care instructions:
Use a soft dry cloth to clean the product.
Do not use household cleaners.
Be careful when adjusting the lampshades.

Suitable for rooms with a height of 230-320 CM.
Certificates: EMC - LVD
Does not comply with US Standards.

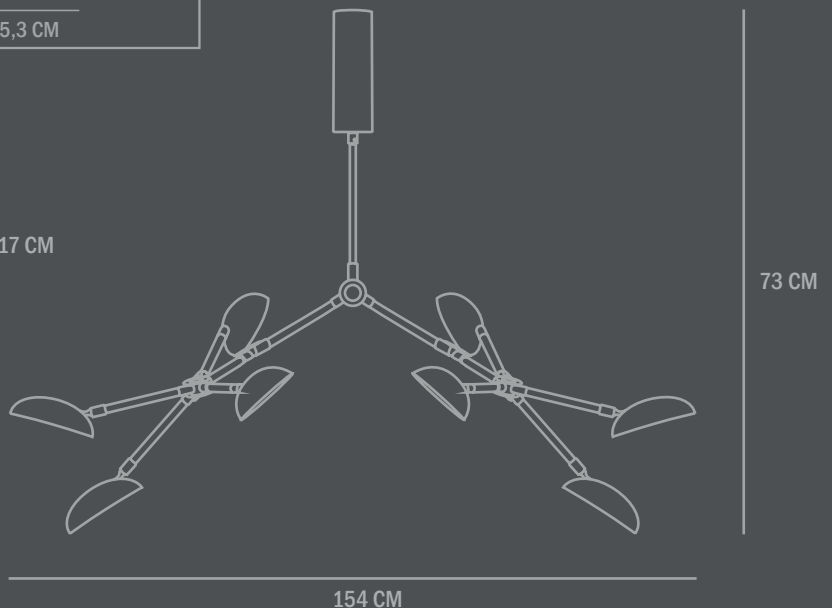
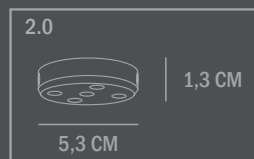
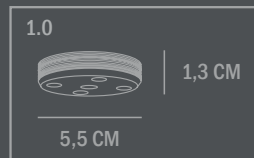

101

C O P E N H A G E N



DROP CHANDELIER BRONZE

You almost feel the movement of the Drop Chandelier. As a free-flowing sculpture, it takes in the space and insists on a life of its own.

While The Drop Chandelier collection honors modernist lamp designs of the 1950s, it also celebrates an experimental, innovative approach with its gently curving shades and 14 flexible and functional adjustable arms - creating countless options, variations, and angles.

The beautifully crafted oxidized and plated, metal body is subsequently hand brushed and the lamp brightens up the room elegantly with a warm, pleasant light.

Designed by Kristian Sofus Hansen & Tommy Hyldahl.

Product no: 214022

Type: Chandelier / Indoor
Colour / Material: Bronze
Designer / Year of design:
Kristian Sofus Hansen & Tommy Hyldahl, 2016

Lampshade & ceiling cup: 100% Iron, with plated Bronze finish. Pipes & attachment parts is made of 100% Iron color Bronze and polished afterwards.
Cable: Fabric covered cable / Black

Dimensions:
L154 / W121 / H73 CM
Mounting plate: H1,3 / W5,5 CM
Ceiling cup: H18 / W6 CM
Fabric covered cable (divided in two):
Cable 1. from 15 to 85 CM / Cable 2. 200 CM

Country of origin: CN.
Product weight: 6 Kgs

Packaging:
Dimensions: L109 / W89 / H21 CM
Total weight incl. product: 8,90 Kgs
Number of parcels: 1
Material: Brown cardboard

Light source:
Socket: E14 - B35 4.3W 827 - 230V
Recommended Light Source:
Pygmy - Matt Porcelain - E14
IP rating: 20 Max Watt: 48

Please note this chandelier is not dimmable.
Dimmability: Can be fitted with an aligned dimmer

Care instructions:
Use a soft dry cloth to clean the product.
Do not use household cleaners.
Be careful when adjusting the lampshades.

Suitable for rooms with a height of 230-320 CM.
Certificates: EMC - LVD
Does not comply with US Standards.

